



X3-Series User Manual

50kW / 60kW



EN

Copy Declaration

The copyright of this manual belongs to SolaX Power Co.,Ltd..Any corporation or individual should not plagiarize, partially or fully copy(incuding software,ect.), and no reproduction or distribution of it in any form or by any means. All rights reserved. SolaX Power Co.,Ltd.,reserves the right of final interpretation.

www.solaxpower.com

Contents

Forward	01
Application Model	01
Intended Audience	01
Symbol Conventions	02
1 Safety Precautions	03
1.1 Personnel Safety	03
1.2 The PV Inverter Protection	03
1.3 Installation Safety	03
1.4 Electrical Connections	04
1.5 Operating and Commissioning	04
1.6 Maintenance	04
1.7 Additional Information	05
2 Overview of the Inverter	06
2.1 Functional Models	06
2.1.1 Function	06
2.1.2 Model Description	06
2.2 Network Application	06
2.2.1 Grid-tied PV Power Systems	06
2.3 Outline and Dimensions	07
2.3.1 Outline	07
2.3.2 Dimensions	08
2.4 Working Modes	09
3 Storage	10
4 Installation	11
4.1 Checking the Outer Packing	11
4.2 Moving the 50K/ 60K	12
4.3 Identify the PV Inverter	12
4.3.1 Nameplate	12
4.3.2 Compliance and Safety Symbols	13
4.4 Installation Requirements	13

4.4.1 Determining the Installation Position	13
4.4.2 Installation Mode Requirements	16
4.5 Support-mounting the Inverter	16
4.6 Installation Self-check	17
5 Electrical Connections	18
5.1 Connecting Protection Ground (PGND) Cables	18
5.1.1 Preparation	18
5.1.2 Wiring Procedures	19
5.2 Connecting AC Output Cables	20
5.2.1 Preparation	20
5.2.2 Procedure of Connecting AC Cables	21
5.3 Connecting the PV Strings	22
5.3.1 Preparation	23
5.4 Connecting Communication Cables	26
5.4.1 Communication Mode Description	26
5.4.2 Connecting RS485 Communication Cables	28
5.4.3 Setting RS485 Communication Address	29
5.5 Installation Verification	30
6 System Operation	31
6.1 Powering ON the Inverter	31
6.2 Powering OFF the Inverter	31
7 User Interface	32
8 Maintenance	36
8.1 Routine Maintenance	36
8.2 The Inverter Troubleshooting	37
8.3 Removing the Inverter	39
9 Quality Guarantee	41
9.1 Quality Terms	41
9.2 Liability Waiver	41
10 Disposal of the Inverter	42
11 Technical Specifications	43

Forward

Dear User,

Thank you so much for your choosing 50K/60K, the latest generation of grid-tied PV Strings inverter (hereinafter referred to as the inverter) designed and developed by our company.

This user manual introduces the inverter in terms of its installation, electrical connections, operation, commissioning, maintenance, and troubleshooting. Please read through the manual carefully before installing and using the inverter, and keep the manual well for future reference.

Application Model

Grid-tied PV string inverter

- 50K
- 60K

Intended Audience







This user manual is intended for photovoltaic (PV) inverter operating personnel and qualified electrical technicians.

Notes:

This user manual is subject to change (specific please in kind prevail) without prior notice.

Symbol Conventions

Safety symbols used in this manual, which highlight potential safety risks and important safety information, are listed as follows:

Symbol	Description
 DANGER	Indicates an imminently hazardous situation which, if not correctly followed, will result in serious injury or death.
 WARNING	Indicates a potentially hazardous situation which, if not correctly followed, could result in serious injury or death.
 CAUTION	Indicates a potentially hazardous situation which, if not correctly followed, could result in moderate or minor injury.
 NOTICE	Indicates a potentially hazardous situation which, if not correctly followed, could result in equipment failure to run, or property damage.
 NOTE	Calls attention to important information, best practices and tips: supplement additional safety instructions for your better use of the PV inverter to reduce the waste of your resource.
 REFER	Refer to documentation (Remind operators to refer to the documentation shipped with the inverter).

1 Safety Precautions

Before beginning your journey, please read these safety precautions in User Manual carefully.

1.1 Personnel Safety

- a. The PV inverter must be installed, electronically connected, operated and maintained through specially trained technician;
- b. The qualified technician must be familiar with the safety regulations of electrical system, working process of PV power generation system, and standards of local power grid;
- c. The technician must read through this User Manual carefully and master it before any operation.

1.2 The PV Inverter Protection

 NOTICE	As soon as receiving the PV inverter, please check if it is damaged during its transportation. If yes, please contact your dealer immediately.
--	--

- a. Do not tamper with any warning signs on the inverter enclosure because these signs contain important information about safe operation.
- b. Do not remove or damage the nameplate on the inverter's enclosure because it contains important product information.
- c. Do not remove the anti-dismantle label on the inverter's enclosure because it is the basis for product warranty.

1.3 Installation Safety

 NOTICE	Please read the User Manual carefully before installing the PV inverter; warranty or liability will be void from our company if damage is caused by installation faults.
--	--

- a. Ensure there is no electrical connections around ports of the PV inverter before installing;
- b. Adequate ventilation must be provided for inverter installation location. Mount the inverter in vertical direction, and ensure that no object is put on the heat sink affecting the cooling. (For details, refer to Chapter 4 Installation)

1.4 Electrical Connections

 DANGER	Before installing the inverter, check all electrical ports to ensure no damage and no short circuit. Otherwise personal casualty and/or fire will occur.
--	--

- a. Input terminals of the PV inverter apply only to input terminals of PV String; do not connect any other DC source to the input terminals.
- b. Before connecting PV modules, ensure that its voltage is within the safe range; when exposed to any sunlight, PV modules can generate high voltage.
- c. All electrical connections must meet the electrical standards of the country or region.
- d. Cables used in electrical connections must be well fixed, good insulation, and with appropriate specification.

1.5 Operating and Commissioning

 DANGER	While the inverter operating, high voltage can lead to an electrical shock hazard, and even cause personal casualties. Therefore, operate the PV inverter strictly according to the safety precautions in the user manual.
--	--

- a. Before getting the permission of electrical power sector in the country / region, the grid-tied PV inverter cannot start generate power.
- b. Follow the procedures of commissioning described in the user manual when commissioning the PV inverter.
- c. Do not touch any other parts'surface except the DC switch when the PV inverter is operating; its partial parts will be extremely hot and can cause burns.

1.6 Maintenance

 DANGER	Power OFF all electrical terminals before the inverter maintenance; strictly comply with the safety precautions in this document when operating the inverter.
--	---

- a. For personal safety, maintenance personnel must wear appropriate personal protective equipment (like insulation gloves and protective shoes) for the inverter maintenance.
- b. Place temporary warning signs or erect fences to prevent unauthorized access to the maintenance site.
- c. Follow the procedures of maintenance stipulated in the manual strictly.
- d. Check the relevant safety and performance of the inverter; rectify any faults that may compromise the inverter security performance before restarting the inverter.

1.7 Additional Information

 NOTICE	To avoid any other unforeseeable risk, contact your dealer immediately, if there is any issue found during operation.
--	---



2 Overview of the Inverter

This chapter introduces the inverter and describes its functional model, network application, appearance, dimensions, and working process etc.

2.1 Functional Models

2.1.1 Function

This series is a three-phase grid-tied PV string inverter (transformer less) that converts the DC power generated by PV strings into AC power and feeds the power into power grid.

 WARNING	The inverter is transformerless. Add an isolation transformer before grounding the positive/ negative terminal of PV modules (like Thin Film module) for operation.
 WARNING	Do not connect PV modules in parallel to several PV inverters for operation.

2.1.2 Model Description

Figure 2.1 shows a model number of the inverter, using 50K as an example.

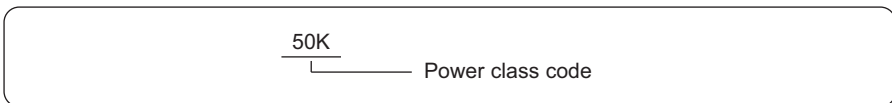

Figure 2.1 Model number descriptions

2.2 Network Application

2.2.1 Grid-tied PV Power Systems

This series applies to grid-tied PV power systems for industrial/commercial rooftops, fishing/farmers light complementary power generation systems, and large ground-based power stations. Typically, these series inverters are used in low-voltage grid-tied PV power system, as shown in Figures 2.2&2.3

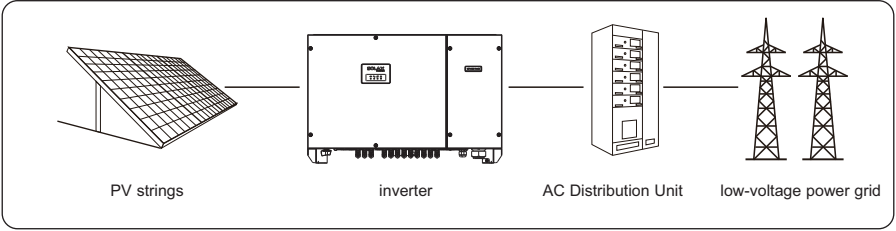

Figure 2.2 a low-voltage grid-tied PV power system

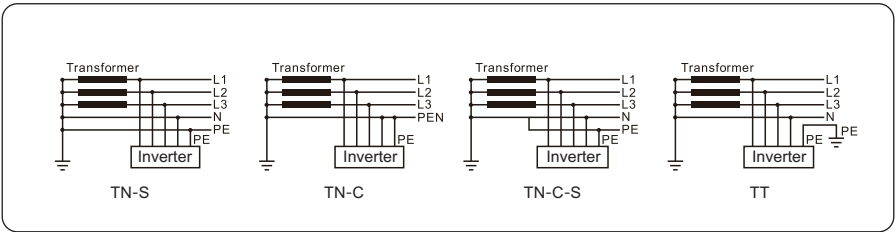

Figure 2.3 Power grids supported by these series inverters

2.3 Outline and Dimensions

2.3.1 Outline

Figures 2.4 to 2.6 show the outline of the inverters as follows:

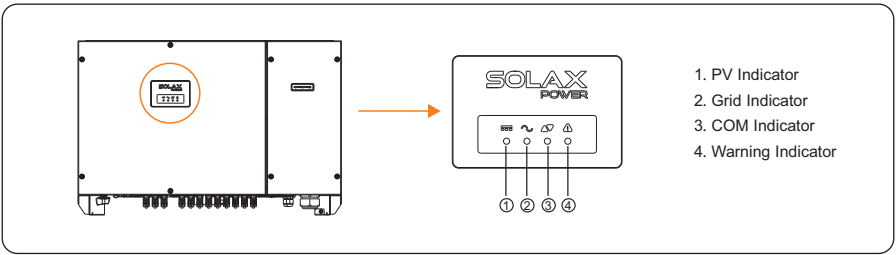

Figure 2.4 The front view and amplification effect of LED indicator area

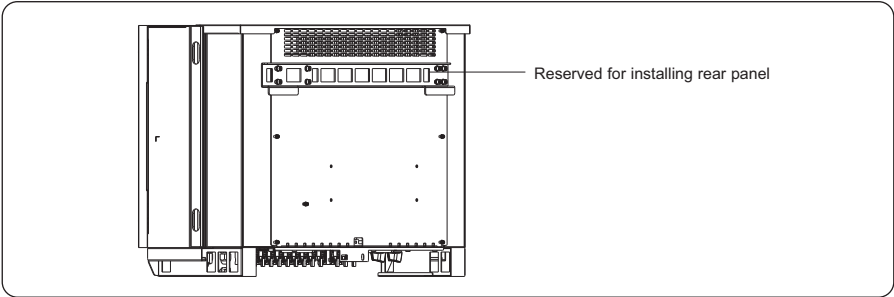

Figure 2.5 The rear view of this series inverter

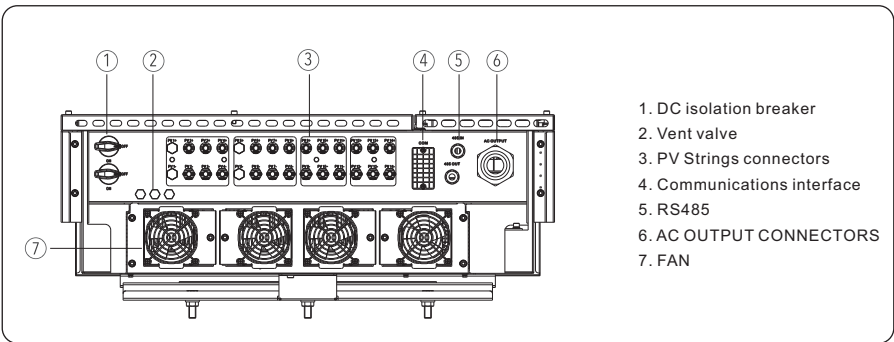
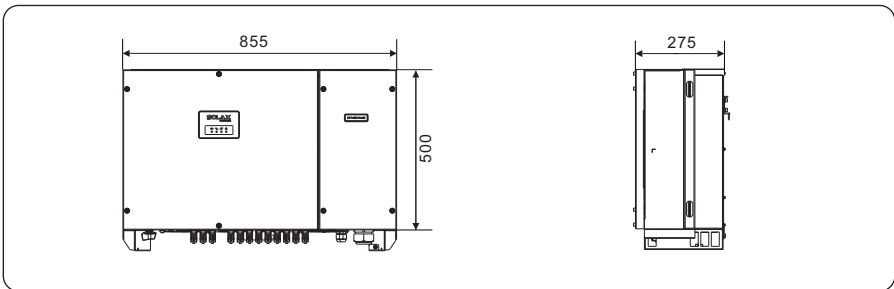

Figure 2.6 The bottom view of this series inverter

2.3.2 Dimensions

Figures 2.7 shows the dimensions of these series inverters as follows:



Figures 2.7 The dimensions of this series (unit: mm)

2.4 Working Modes

Three working modes of the inverter are shown as follows: standby, operating, and shutdown. Table 2.1 shows the conditions for the inverter to switch between working modes.

Modes	Description
Standby	The PV inverter enters the standby mode when >the input voltage of PV Strings can enable auxiliary power supply to run, but cannot meet the inverter operation requirements. >the input voltage of PV Strings can meet the inverter to-start requirements, but cannot meet its minimum power requirements.
Operating	When the PV inverter is grid-tied and generates electricity, it > tracks the maximum power point to maximize the PV String output. > converts DC power from PV strings into AC power and feeds the power to the power grid. The PV inverter will enter to the shutdown mode if detecting a fault or a shutdown command.
Shutdown	The PV inverter switches from standby or operating mode to shutdown mode if detecting a fault or a shutdown command. The inverter switches from shutdown mode to standby mode if receiving a Startup command or detecting that a fault is rectified.

Table 2.1 Working modes description



3 Storage

This chapter describes the storage requirements for the inverter.

The following storage instructions apply if the PV inverter will not be deployed immediately:

- > Do not unpack the inverter (put desiccant in the original box if the PV inverter is unpacked).
- > Store the PV inverter at a temperature range of -40°C to +70°C and with the relative humidity of 0% to 100% (no condensing).
- > The PV inverter should be stored in a clean and dry place and be protected from dust and water vapor corrosion.
- > A maximum of four layers of inverters can be stacked.
- > Do not position the inverter at a front tilt, excessive back tilt, or side tilt, or upside down.
- > Conduct periodic inspection during storage. Replace the packing materials immediately if any rodent bites are found.
- > Ensure that qualified personnel inspect and test the inverter before use if it has been stored for a long time.

4 Installation

 DANGER	Do not install the inverter on flammable building materials or in an area that stores flammable or explosive materials.
 CAUTION	Do not install the inverter in a place where personnel are likely to come into contact with its enclosure and heat sinks to avoid electrical shock/burn.

4.1 Checking the Outer Packing

- When receiving the inverter, check that the packing materials are intact.
- After unpacking, check that the deliverables are complete, intact, and consistent with your order list.
- Examine the PV inverter and its fittings for damage such as scraps and cracks.

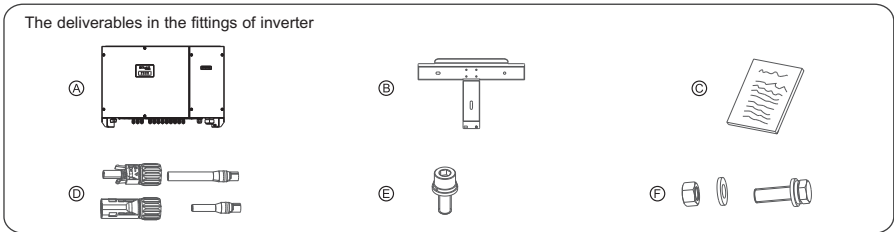

Items	Deliverables
A	The inverter
B	Rear panel
C	File package
D	DC terminal connector group 50K(10*2)/60K(12*2)
E	M6 screw
F	Bolt group (including screw, nut)*3 (reserved for tightening the support and rear panel)

Figures 4.1 The deliverables: The inverter and its fittings



NOTICE

If any damage mentioned above is found, contact the dealer immediately.

4.2 Moving the 50K/60K

After checking the outer packing, move the PV inverter to the designated installation position horizontally. Hold the handles on both sides of the inverter, as shown in Figure 4.2.

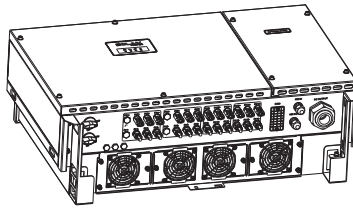

Figure 4.2 Moving the inverter



CAUTION

The inverter is relatively heavy! To prevent device damage and personal injury, arrange two people to move the inverter and handle with care.



CAUTION





>Do not place the PV inverter with its wiring terminals contacting the floor because the power ports and signal ports at the bottom of the device are not designed to support the weight of the inverter.
>When placing the inverter on the floor horizontally, put foam or paper under to protect its enclosure.

4.3 Identify the PV Inverter

4.3.1 Nameplate

After moving the PV inverter from packing box, identify it by reading its nameplate labeled on the side of the inverter. The nameplate contains important product information: the model information, communications/ technical specifications, and compliance symbols.

4.3.2 Compliance and Safety Symbols

Safety symbol	Description
	<p>Electrical shock! There are residual voltages in the PV inverter. It needs 10 minutes to finish discharge.</p>
	<p>The PV inverter must not be touched when in operation. Its enclosure and heat sinks are extremely hot.</p>
	<p>Electrical shock! This part is charged. Only qualified and / or trained electrical technicians are allowed to perform operations on the inverter.</p>
	<p>If the inverter service life has expired, dispose it in accordance with local rules for disposal of electrical equipment waste. Do not dispose the PV inverter with household garbage.</p>
	<p>The PV inverter is compliant with TUV.</p>

4.4 Installation Requirements

According to installation position, two kinds of physical installation are described below in detail: Support-mounting & wall-mounting.

4.4.1 Determining the Installation Position

Basic Requirements

- The inverter is protected to IP65 and can be installed indoors or outdoors.
- The installation method and position must be appropriate for the weight and dimensions of the inverter.
- Do not install the inverter in a place where personnel are likely to come into contact with its enclosure and heat sinks because these parts are extremely hot during operation.
- Do not install the inverter in an area that stores flammable or explosive materials.

Installation Environment Requirements

- The ambient temperature must be below 50°C which ensures the inverter's optimal operation and extends its service life.

- b. The inverter must be installed in a well ventilated environment to ensure good heat dissipation.
- c. The inverter must be free from direct exposure to sunlight, rain, and snow to extend its service life. It is recommended that the inverter be installed in a sheltered place. If no shelter is available, build an awning, as shown in Figure 4.3.

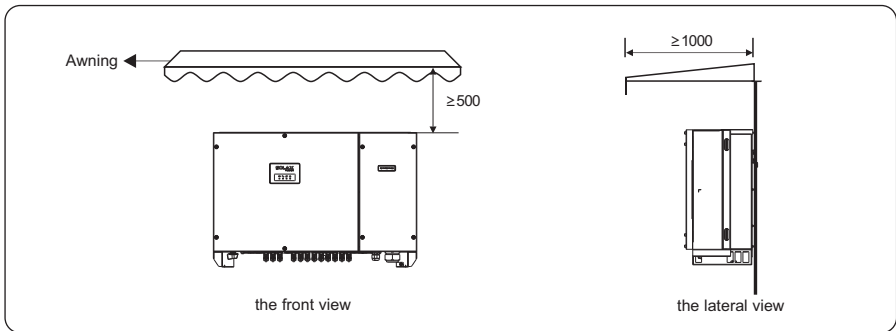

Figure 4.3 Installation environment with awning (unit: mm)

Carrier Requirements

- a. The carrier where the inverter is installed must be fire-proof. Do not install the inverter on flammable building materials.
- b. The wall must be solid enough to bear the weight of the inverter.
- c. Do not install the inverter on a wall made of gypsum boards or similar materials with weak sound insulation to avoid noise disturbance in a residential area.

Installation Space Requirements

- a. It is recommended that the inverter be installed at eye level to facilitate operation and maintenance.
- b. Reserve enough clearance around the inverter to ensure sufficient space for installation and heat dissipation, as shown in Figure 4.4.

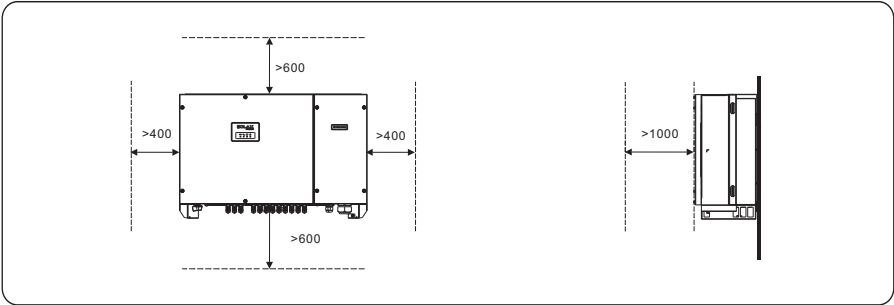

Figure 4.4 Installation Space Requirements (unit: mm)

- c. When installing multiple inverters, install them along the same line (as shown in Figure 4.5) if sufficient space is available, and install them in triangle mode or in stacked mode (as shown in Figure 4.6) if no sufficient space is available. The installation modes ensure sufficient space for installation and heat dissipation.

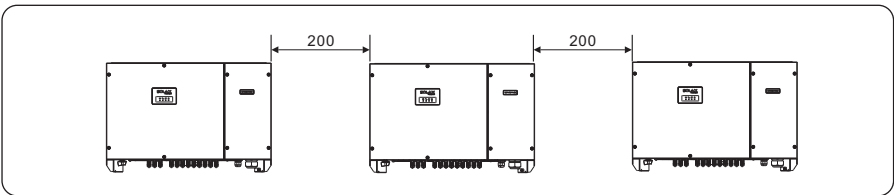

Figure 4.5 Installation along the same line (unit: mm)

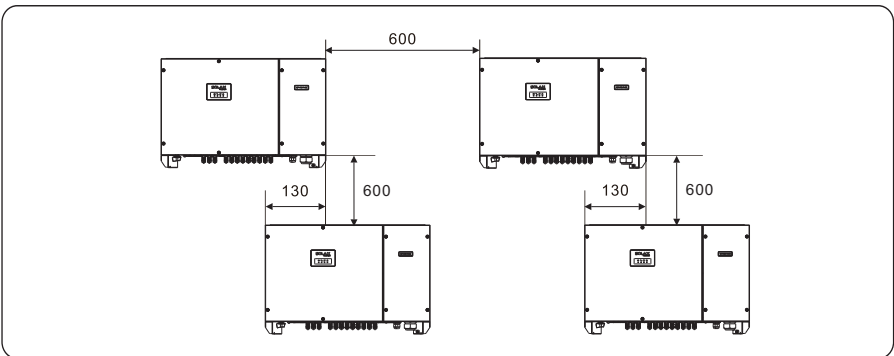

Figure 4.6 Installation in stacked mode



NOTICE

The clearance between multiple inverters must be increased to ensure proper heat dissipation when they are installed in a hot area.

4.4.2 Installation Mode Requirements

Install the inverter upright or at a maximum back tilt of 15 degrees to facilitate heat dissipation. Below are some correct / wrong installation modes, as shown in Figures 4.7&4.8.

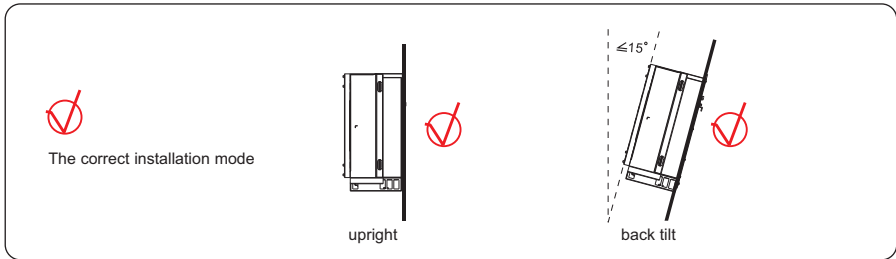

Figures 4.7 The correct installation mode

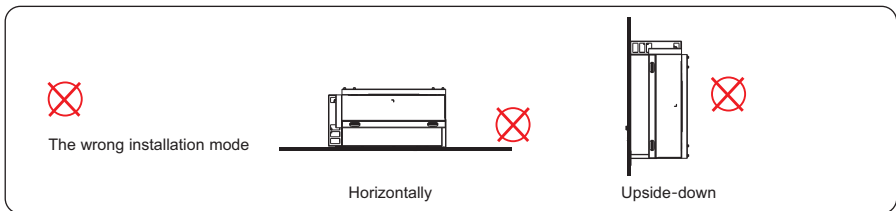

Figure 4.8 The wrong installation modes



NOTICE

The wrong installation will lead to failure of the inverter operation.

4.5 Support-mounting the Inverter

Step 1 Move out the rear panel from the packing case, and determine the positions for the inverter and the support, shown as in Figure 4.9.

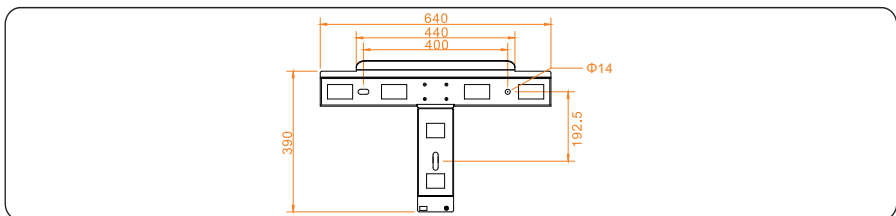

Figure 4.9 The rear panel (unit: mm)

Step 2 Tighten the rear panel with the support using M12 bolt to a torque of 42 N.m (as shown in Figure 4.10).

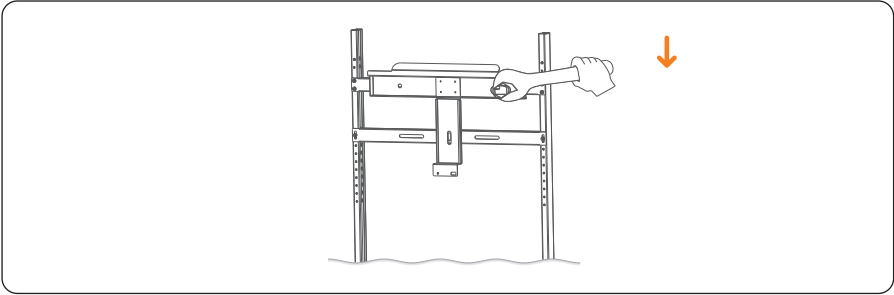

Figure 4.10 Tightening the rear panel with the support

Step 3 Mount the inverter on the support and tighten the inverter with rear panel using screws, as shown in Figure 4.11.

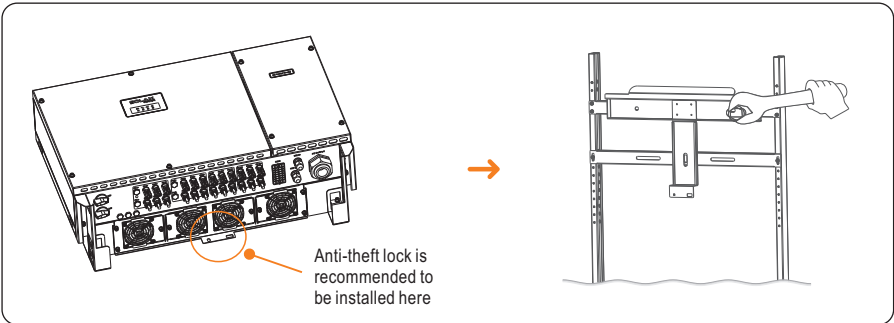



Figure 4.11 Tightening the inverter

4.6 Installation Self-check

- Ensure that the three supporting points (on the rear side of the inverter) align with the three holes of the support;
- Ensure that the inverter is well fixed;
- Ensure that the inverter is locked on the support and an antitheft lock is installed.

5 Electrical Connections

 DANGER	<p>Before performing any electrical connections, ensure that both DC and AC Switches are OFF. Otherwise, fatal injury can occur due to the high voltage caused from AC and DC cables.</p>
 CAUTION	<p>Grounding the PV Strings needs below prerequisites:</p>
<p>An isolation transformer must be installed on the AC side of each inverter; Ensure that the neutral wire of the isolation transformer must be disconnected from the PGND cable.</p>	
<p>One isolation transformer is with one PV inverter: do not install a single isolation transformer for multiple inverters; otherwise, circulating current generated by the inverters will lead to operation failure.</p>	
<p>Select Isolation SET on the mobile APP, and set in Input Grounded, With TF.</p>	

5.1 Connecting Protection Ground (PGND) Cables

5.1.1 Preparation

The ground cable and OT terminals have been prepared with below requirements.

- a. Ground cable: Outdoor multi-core special cables are recommended.
- b. OT terminal: OT terminals OT 35~50-6.

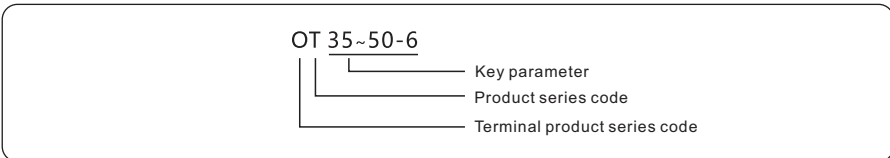

 NOTE	<p>Good grounding for the inverter helps resist the impact of surge voltage and improve the EMI performance. Connect the PGND cable before connecting the AC power cables, DC power cables, and communication cables.</p>
---	---



NOTE

It is recommended that the ground cable be connected to a nearby ground position. For a system with multiple inverters connected in parallel, connect the ground points of all inverters to ensure equipotential connections.

5.1.2 Wiring Procedures

Step 1 Remove an appropriate length of the insulation layer from the PGND cable using a wire Stripper; the length is a little bit longer than that of OT terminal's crimping end by 2mm~3mm, as shown in Figure 5.1.

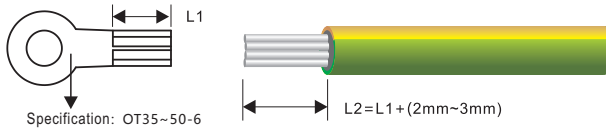

Figure 5.1 Stripped length (unit: mm)

Step 2 Insert the exposed core wires into the crimping areas of the OT terminal and crimp them using hydraulic pliers, as shown in Figure 5.2.

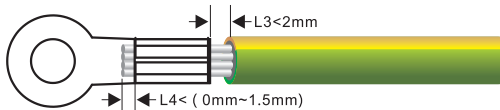

Figure 5.2 Crimping a cable (unit: mm)

Step 3 Remove the ground screws from the ground points, secure the PGND cable (done by step 1 & 2) using the ground bolts, and tighten the bolts to a torque of 3 N•m using a socket wrench, as shown in Figure 5.3. PE wire must be well grounded to ensure that impedance between Neutral wire and Earth wire be less than 10Ω.

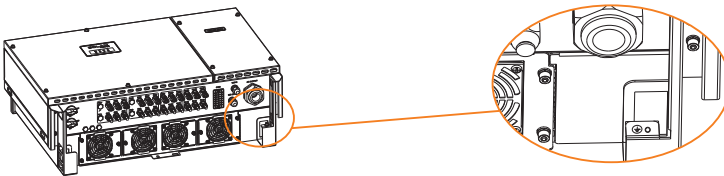

Figure 5.3 Securing the PGND cable

5.2 Connecting AC Output Cables

5.2.1 Preparation



The AC power cable and AC terminals have been prepared with below requirements.

a. AC power cable: Outdoor multi copper-cores cables are recommended. Table 5.1 describes the specifications.

	Cable type	Cross-sectional Area of single strand (mm ²)	Recommended OT terminals	Notes
AC terminal	5-core outdoor special cable	30~50	OT35~50-8	The distances between AC terminal and grid-connection is no more than 200m.
	4-core outdoor special cable			
Protection Ground (PGND) Cables	multi-core outdoor special cable	30~50	OT35~50-8	Terminal connection

Table 5.1 Cable specifications (recommended)

b. AC wiring terminals: An independent three-phase circuit breaker must be installed on the AC side of each inverter to ensure that the inverter can be safely disconnected from the power grid. Do not install leakage current protection switch in the inverter system, and if for special reasons leakage current protection switch is a must between inverter output terminal and power grid, please install a model B leakage current protection switch with no less 600 mA current. Do not share neutral wire when B leakage current protection switch is stalled, or else a power grid trip may occur.

 WARNING	An independent three-phase circuit breaker must be installed on the AC side of each inverter; Do not stall one circuit breaker for multiple inverters.
 WARNING	Connect loads to the AC output terminals of the inverter through circuit breaker.

5.2.2 Procedure of Connecting AC Cables

AC wiring chamber on the right side of the inverter, and before AC wiring, remove these four retaining screws, uninstall Earth wire, and remove the cover of AC wiring chamber. Please follow below steps to ensure equipment and personal safety.

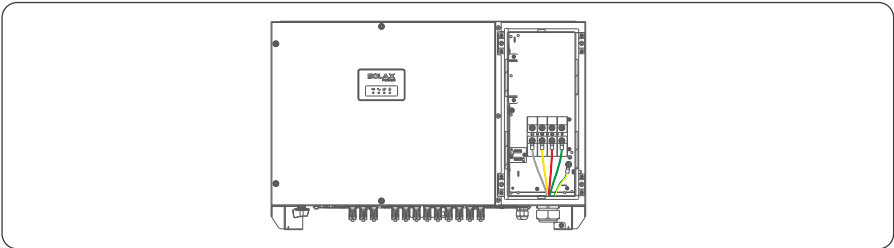

Figure 5.4 Removing the cover of AC wiring chamber

Step 1 Remove an appropriate length of the jacket and insulation layer from the AC output cable. Insert the exposed core wires into the crimp area of the OT terminal, wrap the wire crimp area with heat shrink tubing or insulation tape, and crimp them using hydraulic pliers;

Step 2 Loosen the locking cap from the AC OUTPUT waterproof cable connector at the bottom of the inverter and remove the plug from the locking cap.

Step 3 Route the AC output power cable into the locking cap and the AC OUTPUT connector at the inverter bottom, and connect the AC cable to L1, L2, L3, N, and PE , tighten them using screw driver and the required torque is 12 N.m;

Step 4 Tighten the locking cap on the AC OUTPUT waterproof cable connector to a torque of 12 N.m;

Step 5 Tighten the four screws on the cover to a torque of 3 N.m.

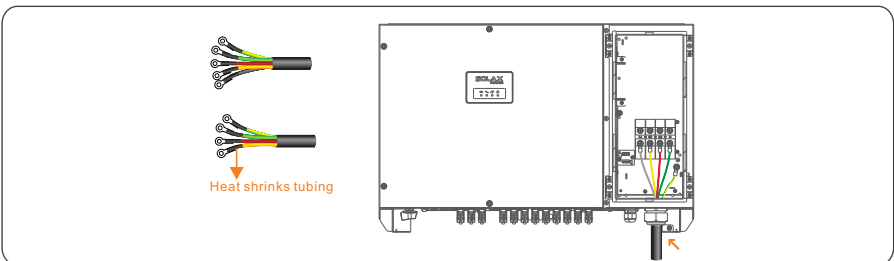

Figure 5.5 Connecting AC Cables



NOTICE

For operation convince and safety, the inverter requires multi-stranded wire and crimping terminals with a proper crimping tool before wiring. To avoid potential risk, 125A / 400VAC overcurrent protection device is recommend to add on the output terminal.

5.3 Connecting the PV Strings



DANGER

PV Strings connection needs below prerequisites; otherwise, an electrical shock can occur.

PV modules generate electric energy when exposed to sunlight and can create an electrical shock hazard. Therefore, when connecting the PV modules, shield them with opaque cloth.

Before connecting DC input power cables, ensure that the voltage on the DC side is within the safe range and that the DC SWITCH on the inverter is OFF. Otherwise, high voltage may result in electric shock.

When the inverter is grid-tied, it is not allowed to maintain DC input power cables, such as connect or disconnect a string or a module in a string. Only after the inverter enters in shutdown mode, it is allowable for preceding DC input power cables maintenance.



WARNING

Grounding the PV Strings needs below prerequisites; otherwise, a fire can occur.

PV modules connected in series in each PV string must be of the same specifications.

The maximum open-circuit voltage of each PV string must be always lower than or equal to its permitted range.

The maximum short circuit current of each PV string must be always lower than or equal to its permitted range.

The positive and negative terminals of PV modules must be connected to the positive and negative DC input terminals of the inverter respectively.

During the installation of PV strings and the inverter, the positive or negative terminals of PV strings cannot be connected with short circuit.

5.3.1 Preparation

PV Strings DC input cable and connectors have been prepared; refer to No. of DC input terminals at the bottom of inverter shown in below figure: 50K with 10 routes and 60K with 12 routes, if quantity of PV strings is less than number of input on inverter, you can refer to below Table for the installation of PV strings and the inverter.

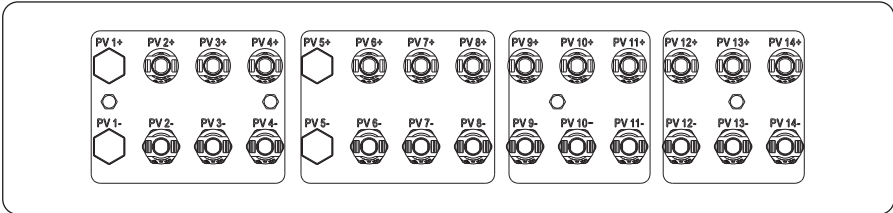

Input Route	Number of Input Route	Inverter model
1	Connected to any route	50K / 60K
2	Connected to routes 2 & 6	
3	Connected to routes 2, 6 & 10	
4	Connected to routes 2, 6, 10 & 13	
5	Connected to routes 2,3, 6, 10 & 13	
6	Connected to routes 2,3, 6, 7, 10 & 13	
7	Connected to routes 2,3, 6, 7, 10, 11 & 13	
8	Connected to routes 2,3, 6, 7, 10, 11, 13 & 14	
9	Connected to routes 2,3, 4, 6, 7, 10, 11, 13 & 14	
10	Connected to routes 2,3, 4, 6, 7,8, 10, 11, 13 & 14	
11	Connected to routes 2,3, 4, 6, 7,8, 9, 10, 11, 13 & 14	Not applicable for 50K
12	Connected to routes 2,3, 4, 6, 7,8, 9, 10, 11, 12,13 & 14	

Table 5.2 Route connecting for the installation of PV strings and the inverter

- Connectors of PV Strings: Positive and negative DC input connectors are used, as shown in Figure 5.6 and Figure 5.7.

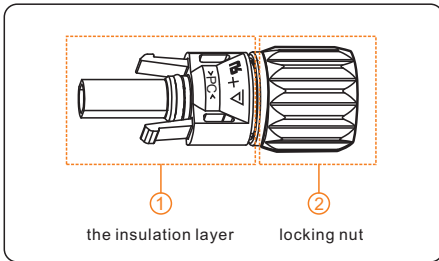

Figure 5.6 Positive connector compositions

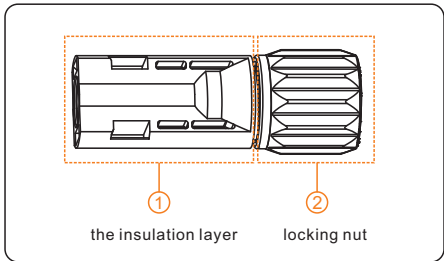

Figure 5.7 Negative connector compositions



NOTE

Positive and negative metal connectors are packed with positive and negative connectors respectively when shipped out. After unpacking, keep the positive and negative ones separate to avoid confusion.

- Procedures of connecting the PV Strings

Step 1 Remove an appropriate length of the insulation layer from the positive and negative power cables using a wire stripper, as shown in below Figure.

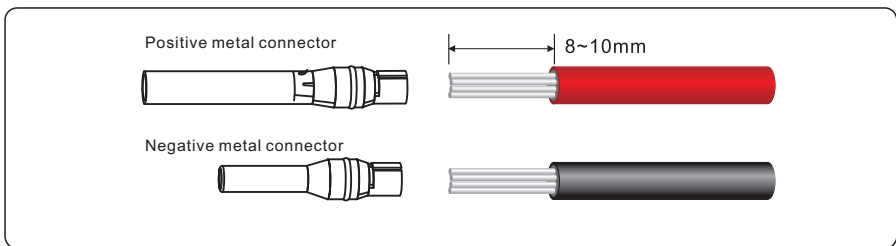

Figure 5.8 Removing insulation layer for DC cable (unit: mm)

Step 2 Insert the exposed areas of the positive and negative power cables into the metal terminals of the positive and negative connectors respectively and crimp them using a crimping tool, as shown in Figure 5.9.

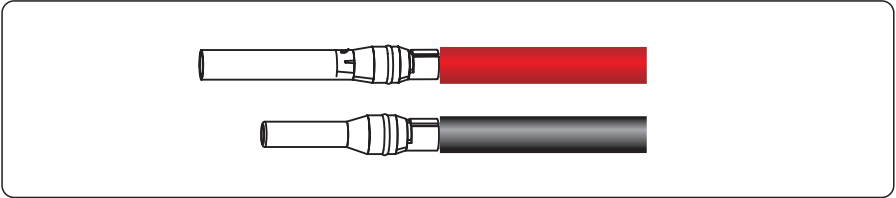

Figure 5.9 Crimping a metal connector

Step 3 Insert the crimped positive and negative power cables into the corresponding positive and negative connectors until a "click" sound is heard, as shown in Figure 5.10.

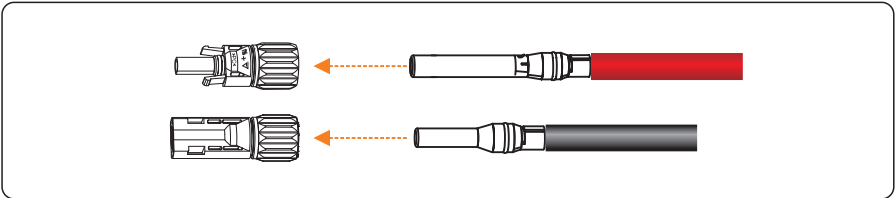

Figure 5.10 Connecting positive and negative connectors

Step 4 Tighten the locking nuts on the positive and negative connectors using a removal wrench, as shown in Figure 5.11.

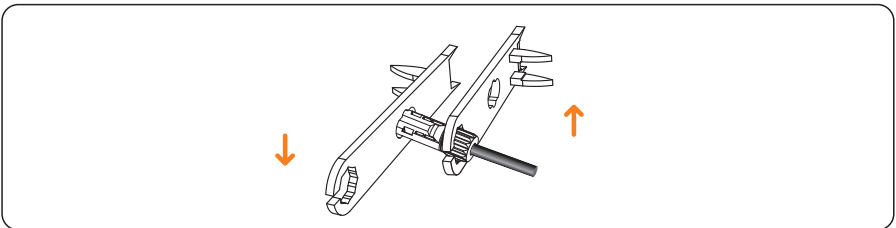

Figure 5.11 Locking connectors

Step 5 Measure the voltage of every route Strings using a multimeter. Ensure that the polarities of the DC input power cables are correct, as shown in Figure 5.12.

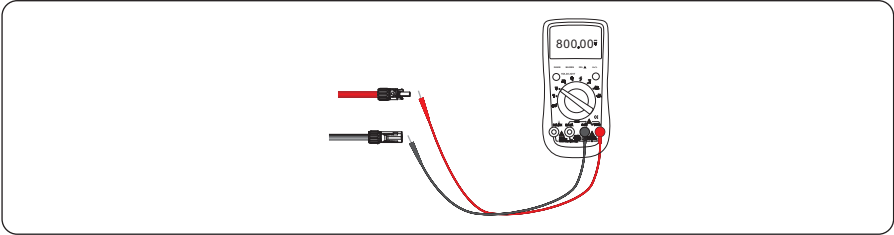

Figure 5.12 Checking the voltage of every route Strings

Step 6 Insert the positive and negative connectors into their corresponding terminals of the inverter until a "click" sound is heard, as shown in Figure 5.13.

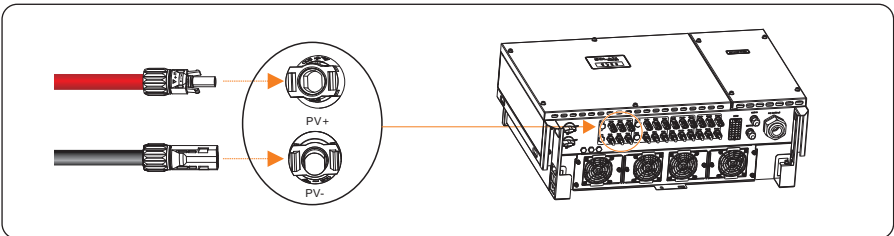

Figure 5.13 Connecting to the inverter

Step 7 After connecting the PV strings, ensure that all connectors are in position by checking for resistance when a slight pull is applied.

5.4 Connecting Communications Cables

5.4.1 Communications Mode Description

You can use the following communications modes to implement communications: Bluetooth, WIFI, GPRS, and RS485, all of which are described as follows.

Bluetooth Module

You can turn on the Bluetooth function of the mobile phone, and set parameters and monitor data of the inverter through the mobile APP.

For details about operation, refer to APP User Manual.

WIFI & GPRS & RS485 Modules

Following figure show inverter's interface to connect WIFI, GPRS and RS485 accessory, please refer user manual of accessory for connecting method and its setting.

Module	Function description
WIFI	WIFI module implements communication with Cloud server through wireless network to monitor PV inverter's data status. For more details, refer to WIFI Product Application Manual.
GPRS	GPRS module implements communication with Cloud server through cellular to monitor PV inverter's data status. For more details, refer to GPRS Product Application Manual.
RS485	RS485 switching module monitors PV inverter's data status through collecting and uploading data to Cloud server. For more details, refer to RS485 switching Product Application Manual.
NOTE	You can choose and buy WIFI/GPRS/RS485 communication modules from our company.

Table 5.3 WIFI & GPRS & RS485 Modules Description



WARNING

Only permitting to connect inverter's communication interface with the original WIFI/GPRS accessory, other brand WIFI/GPRS accessory could damage inverter and no warranty could be provided.

RS485 communications mode (for single inverter)

When RS485 communications mode is applied to monitor the inverter, there are two ways for connecting to the inverter: connecting to single inverter and to multiple inverters. Figure 5.14 demonstrates connection to single inverter to implement RS485 communications.

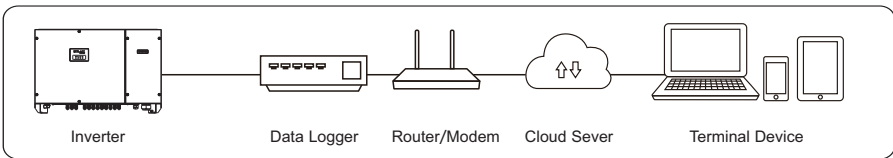

Figure 5.14 RS485 communications mode for a single inverter

RS485 communications mode (for multiple inverters)

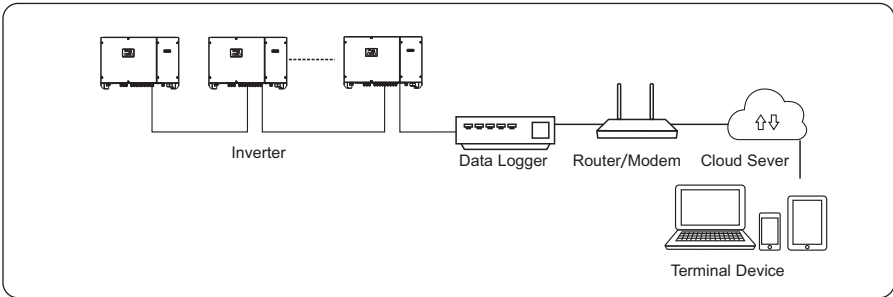

Figure 5.15 RS485 communications for multiple inverters



If multiple inverters are connected, note the following:

- 1) No need for re-setting Modbus address and the address can be allocated automatically if V1000 data logger is used. Otherwise, you need to re-set Modbus address manually through mobile APP if other brand data logger is used. For details, refer to APP User Manual.
- 2) Turn RS485 Resistance to ON from the dial switch of the inverters on the end of the chain.
- 3) Ensure that the appropriate length of communications cable between every two inverters is less than 200m and communications cable must be separated from other power cables to avoid communication interference.

5.4.2 Connecting RS485 Communication Cables

The inverter case right side is located interface of RS485 communication cable, as shown in Figure 5.16.

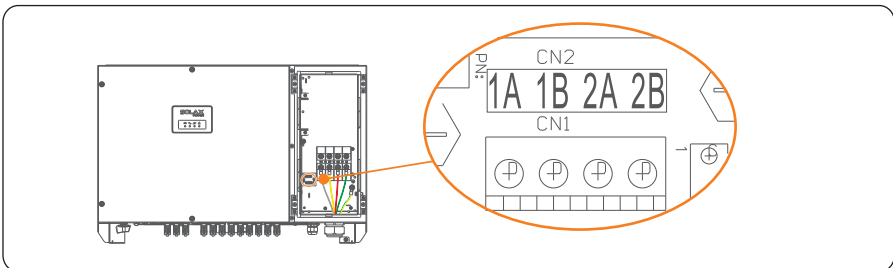

Figure 5.16 Interface of RS485 communication cable

Step 1 Remove the wiring chamber on the right of inverter, and loosen the locking cap on 485 waterproof cable connector from the bottom of inverter.

Step 2 Remove an appropriate length of the insulation layer from the communication cable, loosen screw lock to take out panel, insert the cable to the waterproof cable connector, and tighten the locking cap.

Step 3 Connect RS485 differential positive and negative signal of data logger to terminal 1A and 1B of inverter, and connect terminal 2A and 2B of the inverter to terminal 1A and 1B of another inverter.



NOTE

To prevent corrosion, apply silica gel or fireproof mud to the terminal or interface after connecting external PGND cables, AC cables, RS485 port, and Ethernet port.

5.4.3 Setting RS485 Communication Address

Step 1 Input the company's website in your mobile phone browser and click APP to Download the APP, which is also available by scanning the QR code. And then login the APP and register an account for your inverter.

Step 2 Click the Extension key, and select Setting in the prompt manual, as shown in Figure 5.17.

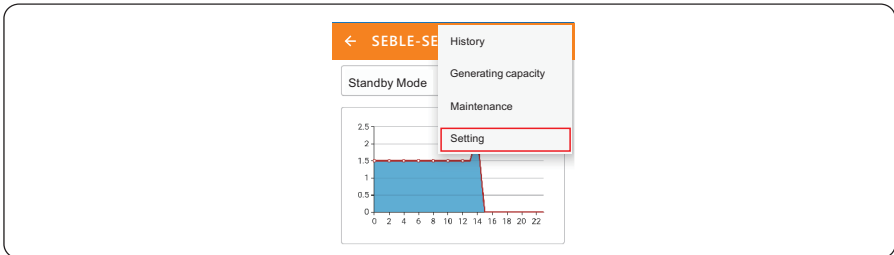

Figure 5.17 APP homepage setting

Step 3 Check the Modbus address in Figure 5.18, the default address is 1, long click to revise the address and save it, the inverter at same RS485 bus must be set a unique address.

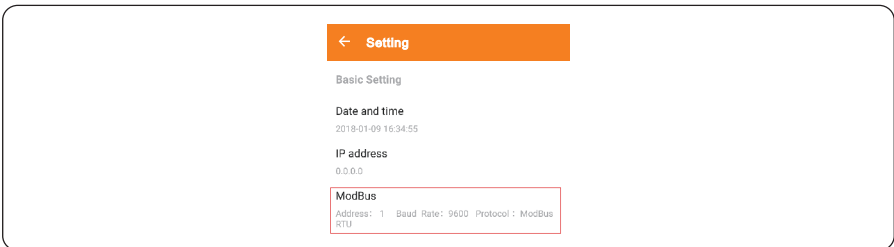

Figure 5.18 Check the Modbus address

Step 4 You can set Mach Resistance of the end of multi-RS485 connection chain, as showed In Figure 5.19.

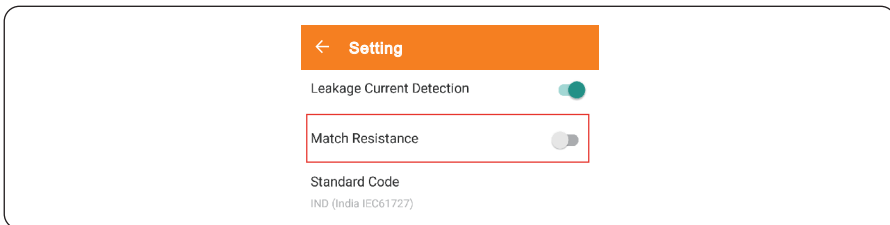

Figure 5.19 Setting Mach Resistances

5.5 Installation Verification

Check the following items after the inverter is installed according to Table 5.4.

1. No other objects put on the PV inverter.
2. All screws, especially the screws used for electrical connections, are tightened.
3. The PV inverter is installed correctly and securely.
4. Ground, AC, DC, and Communications cables are connected tightly/correctly and securely.
5. Check there is no open circuit or short-circuits at AC and DC terminals using multimeter.
6. Waterproof connectors at AC terminals and RS485 ports are plugged with waterproof plugs tightly.
7. Covers at AC terminals are tightened.
8. Idle terminals are sealed.
9. All safety warning symbols are intact and complete on the inverter.

Table 5.4 Self-check items after installation

6 System Operation

6.1 Powering ON the Inverter

Step 1: Switch ON the AC circuit breaker.

Step 2: Set the DC SWITCH of the inverter to ON.

Step 3: Observe statuses of LED indicator lights on the inverter according to Table 7.2.



NOTE

When LED status lights display the inverter has entered grid-connecting, it means the inverter is operating well. Any query during operating the PV inverter, call your dealer.

6.2 Powering OFF the Inverter

Step 1: Switch off the circuit breaker at AC terminal.

Step 2: Set the DC SWITCH to OFF.



WARNING

After the inverter powers off, the remaining electricity and heat may still cause electrical shock and body burns. Please only begin servicing the inverter ten minutes after the power-off.

7 User Interface

There are two types of inverter display: LED indicator and LCD(LCD is optional for some models of inverter). LED indicator includes PV Indicator, Grid Indicator, COM Indicator, and Warning Indicator.

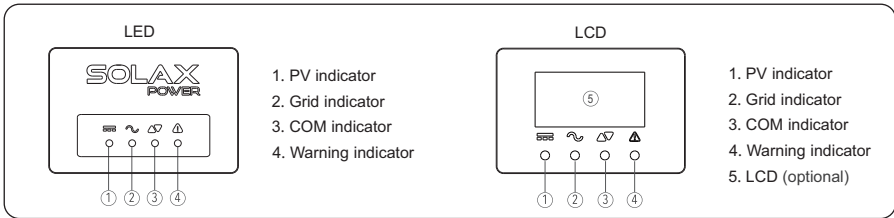

LED indicator	Status	Description
PV Indicator	on	Voltage of PV strings meet the conditions for feed-in operation.
	blink	Voltage of PV strings does not meet the conditions for feed-in operation.
Grid Indicator	blink	Power grid abnormal. The conditions for feed-in operation are not yet met.
	on	Feed-in operation. The blink times (every cycle lasts 30s) of the grid indicator present power size, and after that the indicator keeps ON. When less than 20% rated power, blink one time; 20%~40% rated power, blink twice; 40%~60% rated power, blink three times; 60%~80% rated power, blink four times; 80%~100% rated power, blink five times.
COM Indicator	blink	Communication data transmission is underway.
	off	No external communications is connected or no communications data transmission.
Warning Indicator	on/blink	Refer LED status in warning table
	off	No warning

Table 7.1 LED indicator

LCD Screen

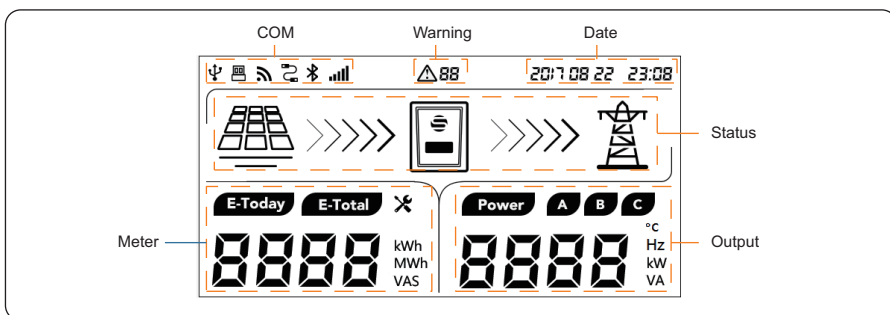

1) COM

When WIFI/GPRS/Bluetooth is transferring data, icon will be ON, while no data transmission, the icon will be off after 10s. When RS485 is transferring data, icon will be ON, while no data transmission, the icon will be off after 10s.

2) Warning

When warning is triggered, icon will be illuminated: from left to right the first bit could be (A)/ (b)/ (C), it stands for warning type, and the second bit is warning code, please refer to warning code in table 7.2 for details.

3) Date

When external communications is normal and time zone is set correctly, the built-in clock of inverter will be synchronized with server's time.



4) Status

Icon stands for PV strings; when inverter is standby status, MPPT voltage of the PV string will be displayed in Meter zone.

Icon stands for grid; when voltage and frequency of power grid is in normal range, the icon keeps on, or else, it blinks; when there is no voltage, the icon will be off.

Icon stands for energy flow; when inverter is in normal status, the icon will be on, or else it will be off.

5) Meter

Normal status: today and total energy, MPPT voltage and current are showed in turn.	
Standby status: counter down value before inverter start up.	
Any status: setting parameters via APP, the screen keep for 5 seconds.	

6) Output

Normal status: output power, grid voltage and current are showed in turn.	
---	---

View Inverter status

The inverter operation status can be obtained from observing LED indicator status. For more details, refer to Table 7.1 LED indicator status.

View and Set Inverter running data

The inverter operation data can be obtained from APP, mobile phone APP downloaded through Bluetooth communication. For more details, refer to APP User Manual.



NOTE

You can view&set data through the inverter APP. For details about operation, refer to APP User Manual.

	Warning code	PV indicator	Grid indicator	COM indicator	Warning indicator
Normal status		●	●/★	◎	○
Starting up		●	○	◎	○
WLAN/WI-FI/RS485 communication		◎	◎	★	○
PV normal		●	◎	◎	○
Grid over voltage	A0	◎	★	◎	○
Grid under voltage	A1	◎	★	◎	○

Grid absent	A2	◎	★	◎	○
Grid over frequency	A3				
Grid under frequency	A4				
Grid unbalance	A6				
PV over voltage	B0	★	◎	◎	○
PV under voltage	B4				
Weak radiation	B5				
Strings abnormal	B3	◎	◎	◎	★
Inverter over temperature	C5				
Fan abnormal	C8				
Insulation resistance abnormal	B1	●	○	○	●
Leakage current abnormal	B2	○	●	○	●
Strings reverse	B7	○	○	●	●
Control power abnormal	C0	○	★	○	●
DC bias current abnormal	C2	★	●	★	●
Inverter relay abnormal	C3	○	●	●	●
Leakage current HCT abnormal	C6	●	●	○	●
System fault	C7	★	★	★	●
DC link voltage unbalance	C9	●	○	●	●
DC link over voltage	CA	○	★	★	●
Internal Communications Fault	CB	○	○	★	●
Software version incompatibility	CC	★	●	○	●
EEPROM fault	CD	★	○	●	●
Sampling inconsistency	CE	★	●	●	●
Invert circuit abnormal	CF	●	●	●	●
Boost circuit abnormal	CG	★	○	○	●

Table 7.2 LED indicator status for common fault of the inverter

Note: ● means light ON, ○ light off ★blink ◎ keep original status.

8 Maintenance

 WARNING	<p>Before maintaining and commissioning inverter and its peripheral distribution unit, switch off all the charged terminals of the inverter and wait at least 10 minutes after the inverter is powered off.</p>
--	---

8.1 Routine Maintenance

Check Item	Check Content	Maintain content	Maintenance Interval
inverter output status	Statistically maintain the status of electrical yield, and remotely monitor its abnormal status.	NA	Weekly
PV inverter cleaning	Check periodically that the heat sink is free from dust and blockage.	Clean periodically the heat sink.	yearly
PV inverter running status	Check that the inverter is not damaged or deformed. Check for normal sound emitted during inverter operation. Check and ensure that all inverter communications is running well.	If there is any abnormal phenomenon, replace the relevant parts.	monthly
PV inverter Electrical Connections	Check that AC, DC, and communications cables are securely connected; Check that PGND cables are securely connected; Check that cables are intact and there are not wire aging;	If there is any abnormal phenomenon, replace the cable or re-connect it.	Semiannually

Table 8.1 Maintenance checklist and interval

8.2 The Inverter Troubleshooting

When inverter enters in shutdown mode abnormally, the alarm light is illuminated. Table 8.2 describes the troubleshooting measures for common fault alarms in the inverter.

Alarm Name	Causes	Measures Recommended
Grid Over Voltage	The grid voltage exceeds its allowable range.	<ol style="list-style-type: none"> 1. If the alarm occurs accidentally, possibly the power grid is abnormal accidentally. No extra action is needed. 2. If the alarm occurs repeatedly, contact the local power station. After receiving approval of the local power bureau, revise the electrical protection parameters setting on the inverter through APP. 3. If the alarm persists for a long time, check whether the AC circuit breaker/AC terminals is disconnected or not, or if the grid has a power outage.
Grid Under Voltage		
Over Frequency		
Under Frequency		
PV Over Voltage	PV modules input voltage exceeds the inverter's allowable range.	Check the number of PV modules and adjust it if need.
PV Under Voltage	PV modules input voltage is under the inverter's defaulted protection value.	<ol style="list-style-type: none"> 1. When sunlight intensity weakens, PV modules voltage decreases. No action is needed. 2. If such phenomena occur when sunlight intensity does not weaken, check if there is short circuit, open circuit etc. in the PV strings.
Insulation Resistance Abnormal	A short circuit exists between PV strings and protection ground. PV strings are installed in a long-term moist environment.	<ol style="list-style-type: none"> 1. Check the insulation resistance against the ground for the PV strings. If a short circuit has occurred, rectify the fault. 2. If the insulation resistance against the ground is less than the default value in a rainy environment, set Insulation resistance protection on APP.

Residual Current Abnormal	The insulation resistance against the ground at the input side decreases during the inverter operation, which causes excessively high residual current.	<ol style="list-style-type: none"> 1. If the alarm occurs accidentally, possibly the external circuits are abnormal accidentally. The inverter automatically recovers to the normal operating status after the fault is rectified. 2. If the alarm occurs repeatedly or lasts a long time, check whether the insulation resistance against the ground of PC strings is too low.
PV Strings Abnormal	PV strings have been shielded for a long time. PV strings are deteriorating.	<ol style="list-style-type: none"> 1. Check whether the PV string is shielded. 2. If the PV string is clean and not shielded, check whether the PV modules are aging or deteriorated.
PV Strings Reverse	The cables of PV strings are connected reversely during the inverter installation.	Check whether the cables of PV strings are correctly connected. If they are connected reversely, reconnect the cables.
BUS Under Voltage	Abnormal internal energy control imbalance has been triggered by the PV Strings/grid sharp change of working conditions	<ol style="list-style-type: none"> 1. If the alarm occurs occasionally, the inverter can automatically recover to the normal operating status after the fault is rectified. 2. If the alarm occurs repeatedly, contact your dealer for technical support.
BUS Over Voltage		
Invert Module Fault		
BOOST Fault		
EEPROM Fault	EEPROM Component damaged	Replace the monitoring board.
Zero power generation and Yellow alarm light illuminating in remote monitor system	Communications outage	If modem or other data logger is used, please reboot it; if still does not work after rebooting, contact your dealer.

remote monitor displays zero power generation	Communications outage	If modem or other data logger is used, please reboot it; if still does not work after rebooting, contact your dealer.
remote monitor displays no output voltage	Output switch tripping	Check if DC switch is damaged, and if not, switch it to ON. If it still doesn't work, contact your dealer.
Inverter off grid	1. Power grid fault; 2. DC switch tripping	1. Wait till power is restored; 2. Turn DC switch to ON, and if DC switch trips a lot, contact your dealer.

Table 8.2 Common troubleshooting measures

 NOTE	If you cannot clear the preceding alarm according to the measures recommended, contact your dealer timely.
---	--

8.3 Removing the Inverter

Perform the following procedures to remove the inverter:

Step 1: Disconnect all cables from the inverter, including communications cables, DC input power cables, AC output power cables, and PGND cables, as shown in Figure 8.1.

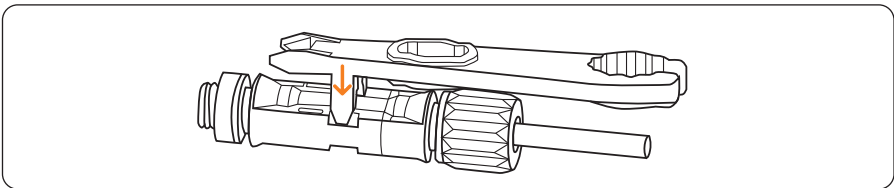

Figure 8.1 Removing DC input connector

Notes:

When removing DC input connector, insert the removal wrench to the bayonet, press the wrench down, and take out the connector carefully.

Step 2: Remove the inverter from the rear panel.

Step 3: Remove the rear panel.



WARNING

Before removing DC input connector, double check DC input switch is turned to OFF to avoid inverter damage and personal injury.

Fan Maintenance

Outer fans are provided to cool the inverter, check periodically and ensure that air inlets and outlets of fans are free from dust and blockage; check whether the ambient temperature of the inverter exceeds the upper limit. If yes, improve ventilation to decrease the temperature. If there is any abnormal noise emitted from the fan, replace the relevant parts timely.

In-built PV FUSE are equipped in the inverter, if any warning display that the FUSE is melt, disconnect AC breaker, and switch the DC switch to OFF; pull out all DC input strings, wait at least 10 minutes after the inverter is powered off. Then open both right and left front panels of the inverter, identify the melt FUSE using multi-meter, and replace them, then install the panels, tighten the screws of invert, and restart the inverter.

9 Quality Guarantee

9.1 Quality Terms

- 1) Where otherwise agreed to in a contract, quality warranty period of the inverter is 60 months
- 2) As for the PV inverter which is defective or damaged within its quality warranty period, our company shall repair or replace it for free.
- 3) The defective/damaged PV inverter replaced must be returned.

9.2 Liability Waiver

Warranty or liability will be void if damage is caused from below operations/situations. If customer asks for maintenance service, our company can, at its discretions, provide paid service.

- 1) The warranty period expired;
- 2) The damage caused during transit;
- 3) The damage caused by man;
- 4) The damage caused by force majeure including, but not restricted to the following:
earthquake, flood, fire, explosion, debris flow etc.
- 5) Operation in adverse environments beyond that described in the User Manual;
- 6) Any installation and operation environment beyond the relevant national standards;
- 7) Any installing, reconfiguring, or using faulty;
- 8) Any revising the product or modifying its software code without authorization;
- 9) Maintenance faulty caused by the technician personnel unauthorized by our company;
- 10) Any operation ignoring the safety precautions stipulated in the User Manual.

10 Disposal of the Inverter

The PV inverter and its packing case are made from environment-friendly materials. If the inverter service life has expired, do NOT discard it with household garbage; dispose the inverter in accordance with local environmental laws and regulations.

11 Technical Specifications

Model	50K	60K
Efficiency		
Max. Efficiency	98.30%	98.30%
European Efficiency	98.00%	98.00%
Input(PV)		
Max. Input Voltage	1100V	
Rated Input Voltage	620V	
Max. Input Current	110A (33A/33A/22A/22A)	132A (33A/33A/33A/33A)
Start Input Voltage/ Min. Operating Voltage	250V/200V	
MPPT Operating Voltage Range	200V-960V	
MPPT Operating Voltage Range (Full-Load)	540V-850V	
Max. Number of PV Strings	10(3/3/2/2)	12(3/3/3/3)
No. of MPPTs	4	
Output(Grid)		
Rated AC Active Power	50,000W	60,000W
Max. AC Apparent Power	55,000VA	66,000VA
Max. AC Active Power (PF=1)	55,000W	66,000W
Max. AC Output Current	3*83A	3*92A
Rated AC Voltage	380V/400V,3W+N+PE	
AC Voltage Range*	277V-520V	
Rated Grid Frequency	50Hz/60Hz	
Grid Frequency Range**	45Hz-55Hz/55Hz-65Hz	
THDI	<3% (Rated Power)	
DC Current Injection	<0.5%In	
Power Factor	> 0.99 Rated power (Adjustable 0.8 Leading - 0.8Lagging)	
Protection		
DC switch	Support	
Anti-islanding protection	Support	
AC overcurrent protection	Support	
AC short circuit protection	Support	
DC reverse connection	Support	
Surge Arrester	DC Type II /AC Type II	

Insulation detection	Support	
Leakage current protection	Support	
General		
Topology	Transformerless	
IP Rating	IP65	
Night Self Consumption	<1W	
Cooling	Fan cooling	
Operating Temperature Range	-25°C-60°C	
Relative Humidity Range	0-100%	
Max. Operating Altitude	4000m(>2000m derating)	
Noise	<62dB	
Dimensions (W*H*D)	855*555*275mm	
Weight	65Kg	67Kg
HMI & COM		
Display	Wireless & APP +LED, LCD(Optional)	
Communication	WiFi(Optional),RS485,GPRS(Optional)	
Certification		
Safety	IEC62109-1, IEC62109-2	
EMC(Optional)	EN 61000-6-2 , EN 61000-6-4	
Grid Code	IEC61727, IEC62116	
Warranty	5 Years/10 Years(Optional)	

Notes:

- 1) Grid power voltage range can be set according to national voltage standards;
- 2) Power grid frequency range can be set according to national grid standards
- 3) The preceding technical specifications are subject to change without prior notice. The listed specifications are for your reference only.



Solax Power Co., Ltd.

No.288 Shizhu Road, Tonglu Economic Development Zone,
Tonglu City, Zhejiang Province, China.

Tel: +86 0571-56260011

E-mail: info@solaxpower.com