

Producto

Batería de GEL Tecatel 12 V 200 Ah
Gel battery Tecatel 12 V 200 Ah

Marca

Tecatel

Código

ES-G200-12

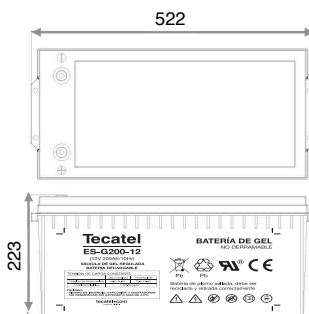

Descripción del producto

- Batería de GEL de gran seguridad.
- Libre de mantenimiento
- Recomendada para bajas y altas temperaturas
- Excelente comportamiento en descargas profundas
- Diseñada para más de 12 años de vida

Product information

- Gel battery safety and no leakage.
- Maintenance free.
- Adapt to high or low temperature.
- Good deep discharge performance.
- Longer cycle life (>12 years)

Especificaciones técnicas / Technical specifications

Método de carga: carga de tensión constante a 25 °C (77 °F) / Charge Method: constant-voltage charging at 25° C (77° F)

Uso cíclico / Cyclic use	14.4 ~ 14.9 V
Corriente máxima de carga / Maximum charging current	50 A
Temperatura de compensación / Temperature Compensation	-30 mV/°C
Uso de flotación / Float Use	13.6 ~ 13.8 V
Temperatura de compensación / Temperature Compensation	-20 mV/°C

Condiciones ambientales de funcionamiento / Environment Temperature Requirements

Temperatura de descarga / Discharge Temperature	-20 ~ 60 °C
Temperatura de carga / Charge Temperature	0 ~ 50 °C
Temperatura de almacenamiento / Storage Temperature	-20 ~ 60 °C

Resistencia interna y corriente máxima de descarga / Inner Resistance & Max. Discharge Current

Batería completamente cargada a 25 °C (77 °F) / A fully charged battery at 25 °C (77° F)	3.5 mΩ
Corriente máxima de descarga / Max. Discharge Current	3.000 A (5 s)
Corriente de cortocircuito / Short Circuit Current	10.000 A

Autodescarga / Self-discharge

3% de la capacidad total por cada mes a 25 °C (77 °F) / 3% Of the capacity per month at 25 °C (77 °F)	
Capacidad después de 3 meses de almacenamiento / Capacity after 3 month storage	0,91
Capacidad después de 6 meses de almacenamiento / Capacity after 6 month storage	0,82
Capacidad después de 12 meses de almacenamiento / Capacity after 12 month storage	0,64

Vida Útil garantizada / Cycle Life guaranteed

En base a número de ciclos y porcentaje de descargas (Ver gráfica) / Based on number of cycles and percentage of discharge (See graphic)

Estructura de la batería / Battery Construction

Componente / Component	Material
Placa positiva / Positive plate	Dióxido de plomo / Lead Dioxide
Placa negativa / Negative plate	Plomo / Lead
Chasis / Container	ABS
Cubierta / Cover	ABS
Válvula de seguridad / Safety valve	Goma / Rubber
Terminales / Terminal	Cobre / Copper
Electrolito / Electrolyte	Ácido gelificado / Gelled acid

Dimensiones y pesos / Dimensions and weights

Largo / Length	522 mm
Ancho / Width	240 mm
Alto / Height	219 mm
Altura total / Total Height	223 mm
Peso / Weight	60 kg

Características funcionales / Functional Parameters

Tensión nominal / Rated voltage	12 V
Número de celdas / Numbers of cell	6 Celdas
Vida útil / Designed life	10-12 años

Capacidad nominal a 25 °C (77 °F) / Rated Capacity at 25° C (77° F)

100 horas nominales (2,3A) / 100 hour rate (2,3A)	230 Ah
20 horas nominales (11,0A) / 20 hour rate (11,0A)	220 Ah
10 horas nominales (20A) / 10 hour rate (20A)	200 Ah
5 horas nominales (35,4A) / 5 hour rate (35,4A)	177 Ah
1 hora nominal (132A) / 1 hour rate (132A)	110 Ah

Parámetros de descarga de corriente constante: en A (25°C)

F.V/Tiempo	20 min	30 min	45 min	1 hora	2 horas	3 horas	5 horas	6 horas	8 horas	10 horas	20 horas
1.80V/Cel	212.97	163.08	122.75	102.86	63.96	48.24	33.85	29.23	23.30	20.00	10.99
1.75V/Cel	239.34	179.34	132.75	110.11	67.80	50.99	35.16	30.22	24.07	20.44	11.21
1.70V/Cel	257.80	192.09	140.99	116.48	71.87	53.08	36.26	31.32	24.73	20.88	11.32
1.65V/Cel	268.35	199.56	145.93	120.88	73.74	54.84	37.03	31.76	25.16	21.21	11.43
1.60V/Cel	290.77	213.63	156.81	128.35	76.70	54.03	38.13	32.53	25.60	21.54	11.65

Parámetros de descarga de corriente constante: en W (25°C)

F.V/Tiempo	20 min	30 min	45 min	1 hora	2 horas	3 horas	5 horas	6 horas	8 horas	10 horas	20 horas
1.80V/Cel	402.31	311.32	236.37	199.23	124.51	94.29	66.59	57.58	46.15	39.89	21.87
1.75V/Cel	447.14	339.23	253.63	212.20	131.43	99.34	68.90	59.45	47.58	40.66	22.31
1.70V/Cel	476.37	360.22	267.36	223.19	138.68	103.19	70.88	61.43	48.90	41.54	22.53
1.65V/Cel	490.33	370.33	274.95	230.33	141.54	105.93	72.20	62.31	49.56	41.98	22.75
1.60V/Cel	525.38	392.64	293.19	243.19	146.59	109.67	74.18	63.52	50.33	42.75	23.08

IMPORTANTE: Las baterías de GEL Tecatel no permiten "Ecuilibración", por lo que de seleccionar erróneamente el tipo de batería en el equipo de carga, dañará este modelo irreversiblemente. Asegúrese de la correcta programación en el cargador para evitar daños.

IMPORTANT: Tecatel GEL batteries do not allow Equalization. Selecting the wrong type of battery in the charging device, will irreversibly damage this model. Make sure the correct programming is set in the charger in order to avoid damage.



Diseñada por Tecatel en España y fabricada en China



8 430549 056978



Especificaciones técnicas batería de Gel ES-G200-12

Charging Characteristics @ 25°C Características de carga de flotación a 25°C

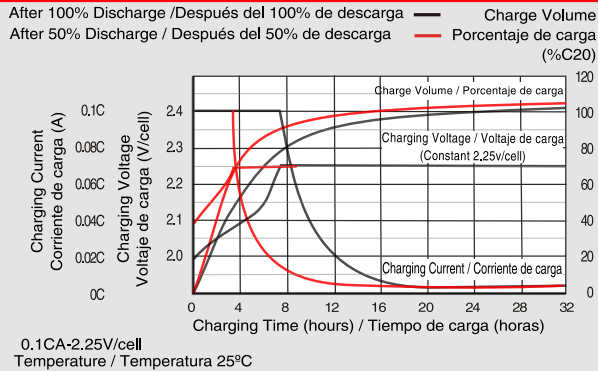

Discharge Characteristics at Varios Rates @ 25°C Características de descarga en diferentes valores a 25°C

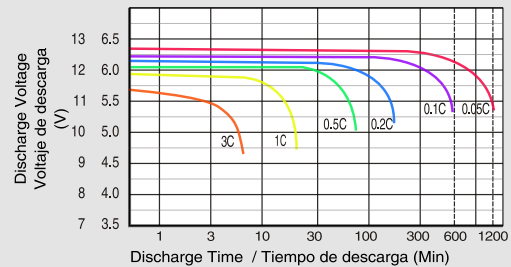

Cycle Life in Relation to Depth of Discharge Ciclos de vida en relación a profundidad de descarga

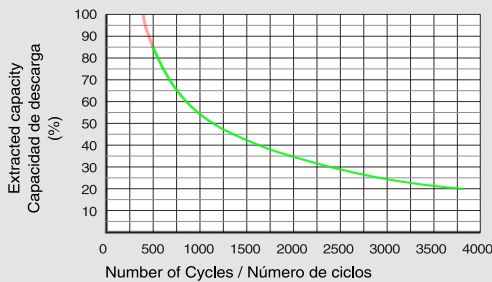

Float Service Life Años de vida con voltaje de flotación

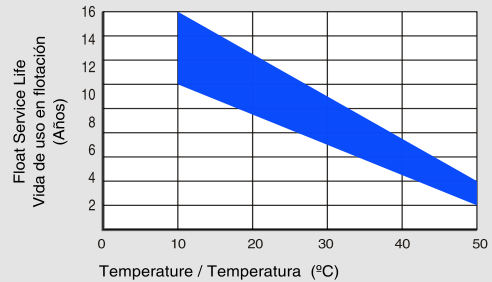

Temperature and Valid Capacity Temperatura en relación a la capacidad de descarga

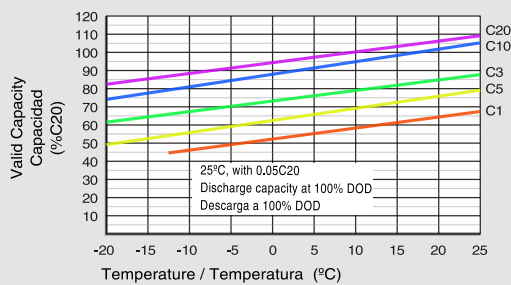

Self Discharge Characteristics Características de autodescarga

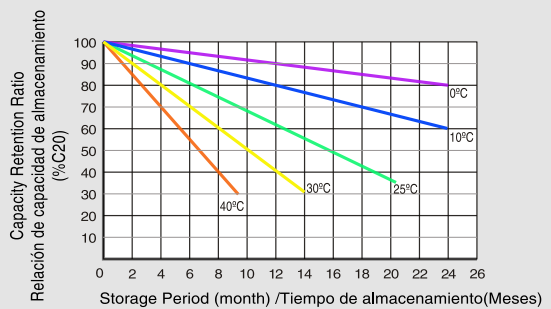

Capacity and Open Circuit Voltage Capacidad y voltaje en circuito abierto

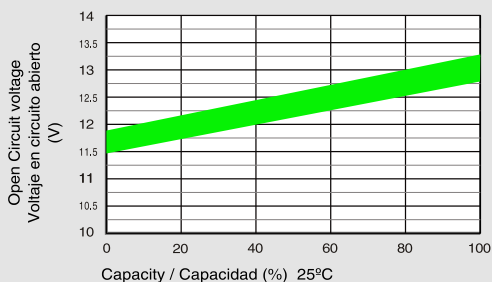

Relationship between Charging Voltage and Temperature Relación entre voltaje de carga y temperatura

